



LABORATORY DESIGN GUIDELINE 2023

 **COLUMBIA UNIVERSITY**
IN THE CITY OF NEW YORK



Welcome!

We are pleased to present this updated Laboratory Design Guideline to our colleagues and consultants across the Columbia University Campuses. This guideline is a collaborative effort by representatives from all CU campuses and provides our client-partners and consultants a comprehensive approach to the laboratory design process through permitting and occupancy.

Our cross-functional team of experts periodically evaluates new technologies, methods and products with the goal of providing best-in-class laboratory facilities across all campuses, as well as providing consistent design of laboratories and collaborative environments for research and teaching.

Specific products, when recommended, are evaluated against multiple criteria including overall durability, maintainability, warranty, sustainability, accessibility, compliance with fire-life safety codes as well as cost. The options presented in this updated guideline reflect these criteria and more.

In this issue we have increased our focus in two areas - 1) sustainability to align with the University's goals of Plan 2030, and 2) universal design to make labs accessible to the broadest range of individuals without the need for specific accommodations.

The Laboratory Design Guideline can be found in these locations:

<https://designconstruct.cufo.columbia.edu/design-requirements>

<https://research.columbia.edu/information-project-managers>

Edward McArthur

VP, Planning & CPM
Morningside Campus

Patrick J. Burke III, FAIA

VP, Facilities Mgmt, Ops & Planning
CUIMC

Denise Ferris

AVP, Design
Manhattanville

CU Collaborators

Jason Cea PM, Morningside

Kim Chen Director, Morningside

Migda Colón-Dieppa PM C&D, Morningside

Hugo Brun-Pantoja Assoc. Director Morningside

Julian Gonzalez Sr Space Planner, Morningside

Jason Gould Director Facilities A&S, Morningside

John Smerdon Director Spcl. Proj. CUMC

Janet Grapengeter Director C&D, Morningside

Phil Kretzmer Assoc. Vice President, MDG

Angela LoPiccolo Facilities Engineer LDEO

Chris Pitoscia Director, EH&S

Chris Semlies Director, Morningside

Charles Ng PM, MDG

Fernando Bedoya Associate Director, CUMC

Partners

Jim Braddock, Mitchell Giurgola

Damian Payne, Loring Consulting Engineers

TABLE OF CONTENTS

01

INTRODUCTION

- 1.1 Purpose
- 1.2 Application
- 1.3 Limitations of the Guidelines
- 1.4 Coordination
- 1.5 Plan 2030
- 1.6 Universal Design

02

CODES STANDARDS | REFERENCES

- 2.1 Codes and Standards
- 2.2 References
- 2.3 Laboratory Permitting

03

DEFINITIONS

- 3.1 Laboratory, Laboratory Unit, Control Area
- 3.2 Laboratory Types
- 3.3 Open Plan/Modular Laboratory Planning
- 3.4 Chemical Fume Hood
- 3.5 Biological Safety Cabinet
- 3.6 Chemical Storage Room
- 3.7 Chemical Storage Cabinet
- 3.8 Compressed Gas
- 3.9 Cryogen
- 3.10 Critical Environment
- 3.11 Critical Equipment
- 3.12 Satellite Animal Facilities

04

PLANNING

- 4.1 Site Selection
- 4.2 Layout
- 4.3 Lab Data Sheet/Test Fit
- 4.4 Laboratory Design Checklist
- 4.5 Laboratory Equipment List
- 4.6 Storage

TABLE OF CONTENTS

05

GENERAL GUIDELINES

- 5.1 General Project Requirements
- 5.2 Building Requirements and Design Issues
- 5.3 Commissioning
- 5.4 Regulatory
- 5.5 Accessibility
- 5.6 Sustainability
- 5.7 Outdoor Air Quality

06

ARCHITECTURAL GUIDELINES

- 6.1 General Finishes
- 6.2 Casework
- 6.3 Furniture
- 6.4 Lighting
- 6.5 Storage/Disposal: Hazardous Waste
- 6.6 Storage/Disposal: Regulated Medical Waste
- 6.7 Acoustic & Vibration
- 6.8 Signage

07

MEP GUIDELINES

- 7.1 MEP Design Considerations
- 7.2 Mechanical & Ventilation/Exhaust
- 7.3 Building Automation System (BAS)
- 7.4 Electrical
- 7.5 Plumbing
- 7.6 Fire Protection

TABLE OF CONTENTS

08

SAFETY AND SECURITY GUIDELINES

- 8.1 General
- 8.2 Eyewash and Overhead Emergency Showers
- 8.3 Biological Safety
- 8.4 Fire and Life Safety
- 8.5 Security
- 8.6 Radiation Safety
- 8.7 Laser Safety
- 8.8 Compressed Gases
- 8.9 Electromagnetic Fields

09

CUIT/CUFO IT REQUIREMENTS

- 9.1 CUIT/CUFO IT Design Considerations

10

SPECIAL ROOMS AND EQUIPMENT

- 10.1 Environmental Rooms
- 10.2 Biosafety Level 2 Laboratories
- 10.3 Imaging Microscopy Rooms
- 10.4 Equipment Rooms
- 10.5 Fume Hood Alcoves
- 10.6 Cell/Tissue Culture Rooms
- 10.7 Glasswash Rooms
- 10.8 Clean Rooms
- 10.9 Laser Rooms
- 10.10 Satellite Animal Facilities
- 10.11 Acoustical Chambers/Shielded Rooms
- 10.12 Mass Spectrometer Room

TABLE OF CONTENTS

11

APPENDICES

- 11.1 Laboratory Requirements Data Sheet
- 11.2 Laboratory Equipment List
- 11.3 Laboratory Design Checklist
- 11.4 ADA Sink and Eyewash Module
- 11.5 Eyewash Standard
- 11.6 Laboratory Signage Checklist
- 11.7 Laboratory Required Signage Sample
- 11.8 Laboratory Permit Checklist
- 11.9 Building Lab Infrastructure



01

INTRODUCTION

1.1 Purpose

The Laboratory Design Guideline (Guideline) is a reference document for Columbia University CPM Project Managers (PMs), Architects and Engineers (A/Es) and Laboratory Design Consultants. It is intended to encourage a thoughtful, consistent, and high level of attention to the design of laboratories and to foster safe, efficient, and collaborative environments for scientific research and teaching.

1.2 Application

This Guideline is primarily relevant to the renovation and construction of “wet” laboratories, or laboratories with specialized facilities or equipment (e.g., electrophysiology, laser labs, acoustical isolation booths, EMF or RF shielded spaces, etc.). Although not primarily intended for “dry” or computational laboratories, components of the Guideline will apply.

1.3 Limitations of the Guidelines

More stringent requirements than contained herein may apply to the design of some laboratories, and such cases should be thoroughly reviewed by all stakeholders and confirmed early in the design process.

1.4 Coordination

All laboratory design teams shall consult with Columbia University Environmental Health & Safety (EH&S), Operations, and Design and Compliance starting at the schematic design phase and continuing throughout the project.

1.5 Plan 2030

Consistent with Columbia’s Plan 2030 (see: [Sustainable Columbia](#)) all stakeholders in the laboratory design process should thoroughly investigate and implement ways of reducing the energy consumed and otherwise minimize the carbon footprint for each laboratory design project. With over 24 environmental academic programs, and approximately 30 centers relating to environmental subjects, the University is a world leader in the environmental sphere.

1.6 Universal Design

The laboratory should be usable by all people, to the greatest extent possible, without the need for adaptation or specialized design. The design team will strive to create an environment that is accessible to people with a wide range of characteristics, including disabilities, thereby minimizing the need for future accommodations.



02

CODES AND STANDARDS/REFERENCES

2.1 Codes and Standards

Laboratories shall be designed to comply with applicable federal, state, and local laws and regulations to facilitate compliance and reporting requirements not limited to the latest edition of the following:

AAALAC International (Association for Assessment and Accreditation of Laboratory Animal Care)

ADA (Americans with Disabilities Act 29CFR 1630)

ASHRAE (American Society of Heating Refrigeration and Air Conditioning Engineers) Standards, Handbooks and Laboratory Design Guide

BCNY (Building Code of the City of New York)

ECCCNYS (Energy Conservation Construction Code of New York City)

EPA (United States Environmental Protection Agency) regulations

IES (Illuminating Engineering Society) Standards JCAHO (Joint Commission on Accreditation of Healthcare Organizations)

LEED (Leadership in Energy and Environmental Design) for Labs

NIH (National Institutes of Health) Design Requirements Manual for Biomedical Laboratories and Animal Research Facilities

NFPA (National Fire Protection Association)

NYCFC (New York City Fire Code) NYCRR (New York City Rules and Regulations)

OSHA (Occupational Safety and Health Administration)

2.2 References

ACGIH: Industrial Ventilation: A Manual of Recommended Practices, Cincinnati, OH. American Conference of Government and Governmental Industrial hygienists.

ANSI/ASSP Z9.5: Laboratory Ventilation, Fairfax, VA. American Industrial Hygiene Association.

ANSI/ASHRAE 110: Method of Testing Performance of Laboratory Fume Hoods. Atlanta, GA. American Society of Heating, Refrigeration, and Air Conditioning Engineers, Inc.

CDC/NIH: Biological Safety in Microbiological and Biomedical Laboratories.

Columbia University EH&S (www.ehs.columbia.edu) for additional Health and Safety Policies and Procedures.

Sustainable Columbia (www.sustainable.columbia.edu) for Ten-year strategic plan outlining sustainability goals to achieve net zero emissions by 2050.

Columbia University Facilities (www.facilities.columbia.edu) for Service Requests and Plant Engineering Standards.

NFPA 45: Standard of Fire Protection for Laboratories Using Chemicals. Quincy, MA: National Fire Protection Association.

New York Health Code Article 175 Radiation Control.

NYC Fire Code 2022: Fire Code for New York City, Hazardous Materials, Section 5002.1 Definitions. 2022

NYC Building Code: Special Detailed Requirements Based on Use and Occupancy Section BC 427.4 Non-Production Chemical Laboratories Definitions.

NFPA 701: Standard Methods of Fire Tests for Flame Propagation of Textiles and Films. Quincy, MA: National Fire Protection Association.

OSHA 1910.1450 (B): PART 1910 Occupational Safety and Health Standards. Subpart 1910.1450 (B) Occupational Exposure to Hazardous Chemicals in Laboratories Definitions.

2.3 Laboratory Permitting

Nonproduction Chemical Laboratories located in New York City where flammable and combustible liquids, oxidizers, or corrosives are used or stored are regulated under The NYC Building Code (2022), which refers to NFPA 45 and the NYC Fire Code. Flammable and combustible liquids are usually (but not always) the limiting hazardous code material in the design of Columbia's labs.

The allowable quantity of flammable and combustible liquids is defined by the BCNY and NYCFC. Laboratories with 1-hour fire rated construction are considered hazard Class D where 15 gallons of flammable and combustible materials are allowed. Laboratories with 2-hour fire rated construction are considered hazard Class B where 25 gallons of these materials are allowed.

In the design of large laboratories 1 gallon of flammable and combustible liquids per 100 square feet of lab area up to a maximum of 100 gallons (which may be increased to 200 gallons if the enclosing construction is 2-hour rated) may be allowed.

An alternative path for determining allowable quantities of hazardous materials is to use control areas as described in the NYCFC instead of laboratory units. Under this approach the design and number of control areas are limited by the floor level. Hazardous material utilization is reduced on higher floors and is not allowed above the 9th floor level, however greater quantities are generally permitted on the lowest floors.

It is critical that the maximum allowable quantities of relevant hazardous materials be reviewed with stakeholders, especially the principal investigator (PI) and Environmental Health & Safety and documented during the design process as Code Compliance drawings.

Permits from FDNY are required for laboratories as set forth in the NYCFC.

Appendix 11.8 lists documents required by FDNY in the permitting process.

Chemical Storage Rooms and manifold rooms that service other labs require, along with approval from DOB, that plans be submitted to and approved by FDNY Tech Management Unit.

Note: There are numerous references in the Guideline to compliance with FDNY and NYC DOB or BCNY requirements. At the Lamont Doherty Earth Observatory and Nevis campuses local building department requirements apply.



03

DEFINITIONS

3.1 Laboratory, Laboratory Unit, Control Area

Laboratory - A building or portion thereof wherein chemicals or gases are used or synthesized, above applicable quantities, on a nonproduction basis for testing, research, experimental, instructional, or educational purposes, or where potentially hazardous equipment (such as a laser) is used.

Laboratory Unit - An enclosed space of appropriate fire-rated construction, designed or used as a nonproduction laboratory. Laboratory units may include one or more separate laboratory work areas, and accessory storage rooms or spaces within or contiguous with the laboratory unit, such as offices.

Control Area - Spaces within a building where amounts of hazardous materials not exceeding the maximum allowable quantities per control area are stored, handled, or used, including any dispensing.

3.2 Laboratory Types

Wet Lab - A lab where chemicals and other potentially hazardous materials are used and stored.

Wet Lab: A lab with fixed casework bays, benchtop equipment, and some specialty equipment setups on movable case work.

Biology-based wet labs typically have some fume hoods and biosafety cabinets; Chemistry-based labs have multiple fume hoods. Wet labs typically use, store or require access to chemicals and other potentially hazardous materials. Wet lab examples include cellular and tissue-based research labs.

Dry Lab - A lab with minimal chemicals or other hazards associated with a wet lab.

Computational Dry Lab: A lab with workstation furniture and minimal fixed casework, and no fume hoods or similar equipment. Dry labs typically utilize minimal chemicals or other hazards associated with a wet lab. Computational labs sometimes require data and electrical connectivity for computer workstations. Lab research examples include sensors, graphics, imaging, and programming.

Dry Lab - Equipment based: A lab with an open floor plate and minimal fixed casework, and movable casework, vibration isolation tables, and research equipment setups. Labs can require an overhead utility spine, minimal fume hoods or typically one fume hood, and snorkel exhausts. Labs often require specialized environmental conditions, vibration sensitivity, daylight control and other conditions.

Dry Labs may have some limited use of hazardous chemicals for processing and materials research. Lab examples include Laser labs, optics, nanoscience, materials science. (This definition is in place of a Laser lab and covers the 'research lab' type.)

Dry Lab- Large Equipment based: A lab with an open floorplate for very large equipment; movable casework, some floor-mounted equipment, floor loading requirements, and high ceiling clearance requirements. Labs can include overhead racks and mounted equipment. Access to materials storage and a loading dock are often required.

Laser Lab - A lab containing a device that stimulates and amplifies atoms or molecules to emit coherent light. Lasers can present a hazard, particularly to eyes, when used in laboratories, and their installation and use involves strict protocols and containment. Lasers are labeled with safety class numbers from 1 (safe) to 4 which can burn skin.

Computational Lab - A lab where work is conducted in an office environment and where hazardous materials and processes are not used.

Research Lab - A facility for conducting scientific or engineering research which requires a range of specialized conditions or equipment.

Class (Teaching) Lab - A facility for enhancing the development and knowledge of scientific or engineering students where hazardous materials may be used in demonstration or presentation by an instructor to a group, often with the aid of an audiovisual system.

Teaching Lab: the original definition is generally OK; suggest adding information about storage and experiment setup requirements, chemical storage, instructional AV, whiteboard/ chalkboards.

3.3 Open Plan/Modular Laboratory Planning

A lab designed with few walls and minimal use of enclosed rooms, where lab benches, services and lighting are organized on a recurring module of approximately 10-11 feet, or multiples thereof, with the intention of creating flexibility in space assignments as lab groups expand/contract, and in making physical changes at minimal cost.

3.4 Chemical Fume Hood

A ventilated enclosure used in a laboratory to contain and exhaust potentially hazardous or noxious vapors, gases, mists, and/or particles.

3.5 Biological Safety Cabinet

An enclosure used in a laboratory to protect the user from exposure to pathogenic microorganisms through the control of airflow and use of HEPA filters.

- 3.6 Chemical Storage Room
A room where laboratory chemicals and/or gases are stored and not otherwise used or synthesized. Requirements regarding chemical storage rooms are contained within BCNY.
- 3.7 Chemical Storage Cabinet
A cabinet designed and constructed in accordance with UL 1275 and used for the storage of flammable and combustible liquids.
- 3.8 Compressed Gas
Any gaseous element or compound or mixture which exerts in the packaging an absolute pressure of 280 kPa (40.6 pounds per square inch absolute, psia) or greater at 20°C.
- 3.9 Cryogen
Substances used to produce very low temperatures, such as liquid nitrogen, that are not inherently hazardous, but which are heavier than, and can displace air, and as such can become asphyxiants.
- 3.10 Critical Environment
Spaces appropriate for experimental setups which are sensitive to one or more of the following: temperature or humidity change, vibration, acoustic levels, magnetic or radio fields, dust/cleanliness.
- 3.11 Critical Equipment
Equipment that requires backup or protections beyond what is generally required, i.e., storage freezers for rare samples which require backup power, or equipment that supports animal life.
- 3.12 Satellite Animal Facilities
Any facility for holding animals for greater than 12 hours outside an IACUC (Institutional Animal Care and Use Committee) recognized central animal facility, where husbandry is generally provided by the Principal Investigator and their staff. Any such proposed facility must be approved by IACUC.



04

PLANNING

4.1 Site Selection

Select a site with appropriate environmental characteristics and adequate infrastructure to support the requirements of the laboratory or verify that all stakeholders understand the implications (cost, time, etc.) of mitigating environmental issues and/or providing additional infrastructure as part of the project. Whenever possible, the site selected should be proximate to other labs engaged in related research to facilitate sharing of ideas, resources, and equipment.

4.2 Layout

- To the extent possible, laboratories should be oriented to take advantage of natural lighting (with consideration for controlling sunlight and glare). Operable windows are not acceptable in laboratory space.
- Laboratory space should be separate from offices, common space, and equipment room space.
- Occupants should not have to pass through a laboratory space to exit from non-laboratory areas.
- Laboratories should be designed to minimize foot traffic in areas where air flow sensitive devices (biological safety cabinets, fume hoods) are in use.
- Each door from a hallway into a lab should be a minimum of 36" wide (42" preferred) and have a view panel. Door sizes shall be coordinated to allow for equipment and cart access and wall protection if required.
- Modular design of lab casework, services and lighting is a preferable approach and is highly encouraged to allow for flexibility for future changes.
- Movable and adjustable height lab bench systems with services delivered from above, preferably via quick disconnects are preferred and are highly encouraged.
- Mechanical and electrical devices should be readily accessible with localized shut off per direction by Facilities.
- If possible, a breakout area should be available for collaboration and where eating and drinking will be permitted. This should be external to permitted lab space.
- To the extent practical, projects with heavy computing programmatic requirements such as bioinformatics should have servers situated in a computer room external to a wet lab environment. Such projects should be designed for maximum energy efficiency suitable for the programmatic and functional requirements of the project. Off-site options shall be reviewed as part of the due diligence process.
- Dedicated lab mechanical rooms must be accessible via the common corridor for maintenance (i.e. without having to go through the lab).
- Consider access and logistics for lab gas tank storage and changeover.

- 4.3 Laboratory Requirements Data Sheet/Test Fit
The attached (see Appendix 11.1) Laboratory Requirement Data Sheets, which consist of a generic plan test fit configuration, room finish, circulation, HVAC, system/utility requirements, and equipment layouts are provided by Columbia's Planning Office at the beginning of each project. The information contained in Lab Data Sheets must be confirmed and developed by the design team as part of the project through further discussions with the lab group, CUF, EHS and other stakeholders.
- 4.4 Laboratory Equipment List
The attached (see Appendix 11.2) standardized Laboratory Equipment List spreadsheet has been developed to assure that information provided by lab groups and confirmed through survey by the consultant team is complete and accurate. Laboratory equipment should be keyed to drawings. The Laboratory Equipment List should be developed through the design process and ultimately included as part of the construction documents.
- 4.5 Laboratory Design Checklist
The attached (see Appendix 11.3) Laboratory Design Checklist of tasks for each phase has been developed to assist the project manager and consultant team to assure that the design process is thorough and complete. The Laboratory Design Checklist should be completed by the design team and submitted with other documents at the end of each phase.
- 4.6 Storage
It is critical to plan for adequate and appropriate storage as part of the laboratory design process. Storage needs should be discussed with the lab group and CUF representatives beginning early in design. Due to space constraints on all of Columbia's campuses consideration should be given to elimination of redundant items, sharing of equipment and other resources, and, where appropriate, off-site storage. In accordance with FDNY requirements stored items shall not extend closer than 18" to the ceiling where the coverage of sprinkler systems could be affected.



05

GENERAL GUIDELINES

5.1 General Project Requirements

Meeting Columbia's educational and research goals as well as health, safety and operational imperatives should be the guiding principles for the design team. Attention to detail is extremely important to the success of laboratory design. It is incumbent upon the design team to ascertain the needs of the project. If the project is funded by a grant, the design team should become familiar with any design requirements of the granting agency, addressing those requirements, and assisting Columbia with any submissions to that agency.

5.2 Building Requirements and Design Issues

Each of Columbia's laboratory buildings is unique in its age, systems, infrastructure, column spacing, floor-to-floor height and other characteristics. Some buildings have limitations with regard to addition of fume hoods. As such, it is critical that the design team carefully survey all spaces affected by a laboratory project, bring to the attention of CUF any observations that might unduly constrain the project, and coordinate survey findings with the project manager, CU Commissioning, CU Operations and other stakeholders. It is critical that affected systems be tested to verify that capacities are sufficient to support the project. The design team will assist in the development of a testing spec based upon the requirements of the project.

5.3 Commissioning

All laboratory projects will be commissioned in accordance with a plan developed by either in-house Facilities Operations personnel or a third-party provider. The design team will develop, draft, and finalize the "owner's project requirements", "design intent", and "basis of design" portions of the commissioning plan with support from the assigned University Project Manager, Environmental Health & Safety (EH&S), Facilities, commissioning provider and the University client. The commissioning provider will develop verification and functional performance testing requirements and operation and maintenance criteria. Parameters for energy, water consumption, sizing of utility services and distribution, must be addressed early in the project. These parameters must be established in the schematic phase. See Columbia University Facilities Design Requirements, Section 230800 Morningside and Section 019113 Manhattanville.

It is very important that sufficient time be allocated for commissioning at the end of construction and prior to project occupancy.

Also, the design team should confirm that the contractor submits and places on Columbia's project management platform all required construction photographs, test reports, and closeout documents.

5.4 Regulatory Approvals

A Professional Engineer (PE) or Registered Architect (RA) must provide signed and sealed documents, all necessary affidavits, and documents for full Department of Buildings (DOB) and FDNY compliance and approvals (or to applicable local code/AHJ for Nevis and Lamont Doherty).

Self-Certification of building department documents is acceptable only with prior written direction from Columbia.

The design team is responsible for responding to comments from the University insurance underwriter for conformity with policy design requirements.

5.5 Accessibility

See Columbia University Facilities Design Requirements, Section 000018. Columbia is committed to fostering a barrier free environment.

5.5.1 Regulatory Compliance

Columbia is subject to regulations under federal, state, and local laws and codes that require minimum design requirements for people with disabilities.

5.5.2 Accessible Lab Design - General

The design of laboratories should reflect and incorporate the principles of universal design:

- Place facilities for equipment, chemicals, safety equipment, controls, and operating mechanisms at a height that is accessible from a seated position and limits extended reaching.
- Avoid positioning of equipment in places that would require one to reach over anything hazardous.
- Provide workspace that accommodates both left-handed and right-handed users.
- The rotational requirements of educational programs necessitate that labs be fully accessible without the need for adaptation.

5.5.3 Lab Benches

At least one bench in each laboratory must be provided with countertop height, knee space dimensions, etc., that comply with ADA and other regulatory accessibility requirements.

5.5.4 Lab Sinks

In accordance with building codes, at least one sink in each laboratory must be designed to comply with ADA and other regulatory accessibility requirements regarding height, knee space dimensions, sink depth, fixture location and type, etc.

5.5.5 Fume Hoods

At least one fume hood in each laboratory must be designed to comply with ADA and other regulatory accessibility requirements regarding countertop height, knee space dimensions, fixture location and type, etc.

Fume hoods must comply with the FDNY requirement for 100 fpm face velocity at a 12" sash opening. They should be high performance type and may be constant or variable air volume type depending on the HVAC system of the building or portion of the building in which they are installed. Fume hoods shall have a minimum exhaust volume of 25 cfm/sf of work surface in accordance with NFPA 45.

Fume hood placement:

1. Fume hoods should be located as far away from egress doors and laboratory traffic patterns as possible.
2. Fume hoods should be located away from supply and exhaust diffusers and any other items that could be a source of turbulence.
3. Fume hoods should not be located adjacent to or across from desk/computer workstations.
4. Fume hoods should not be placed where a safety hazard to lab occupants might be created.

All fume hood installations shall be tested in accordance with ASHRAE 110 by an independent testing agency prior to acceptance by Columbia University. After review and acceptance of test results EHS will certify and label hoods for use. Ductless fume hoods are not allowed unless specifically approved by EHS.

Controls for services shall be clearly labeled and mounted on the exterior of fume hoods. Use of cupsinks in fume hoods is not allowed unless specifically approved by EHS. Where cupsinks are approved, they shall be provided with lips above the countertop surface. Storage below fume hoods shall comply with FDNY and other applicable requirements.

All interior and working surfaces of fume hoods shall be impervious to moisture and highly resistant to chemicals.

Fume hoods complying with the above by the following manufacturers are acceptable:

1. LabCrafters
2. Mott Scientific
3. BedcoLab

Use of fume hoods by other manufacturers is subject to review and approval by CUF. Radioisotope fume hoods are constructed with internal surfaces impermeable to radioactive materials. Perchloric acid fume hoods are for the use of highly oxidizing agents forming vapors that could cause explosion, are constructed of materials that are impervious to and non-reactive with perchloric acid and require an internal washdown system. Radioisotope or perchloric acid fume hoods shall only be provided upon approval of EHS and in accordance with applicable regulations.

5.6 Sustainability

See Columbia University Facilities Design Requirements, Sections 018113, 018113A, 018113B and 019900. Columbia University is committed to reducing its environmental footprint. This stewardship commitment extends to all administrative departments.

5.7 Outdoor Air Quality

The University's Manhattan campuses are situated in areas that have amongst the highest rates of asthma and childhood asthma in the United States. Moreover, these campuses are in environmental justice zones. Particulate emissions and other air pollutants shall be considered in laboratory design and operations to minimize such emissions and promote the health of the residents of the surrounding communities.

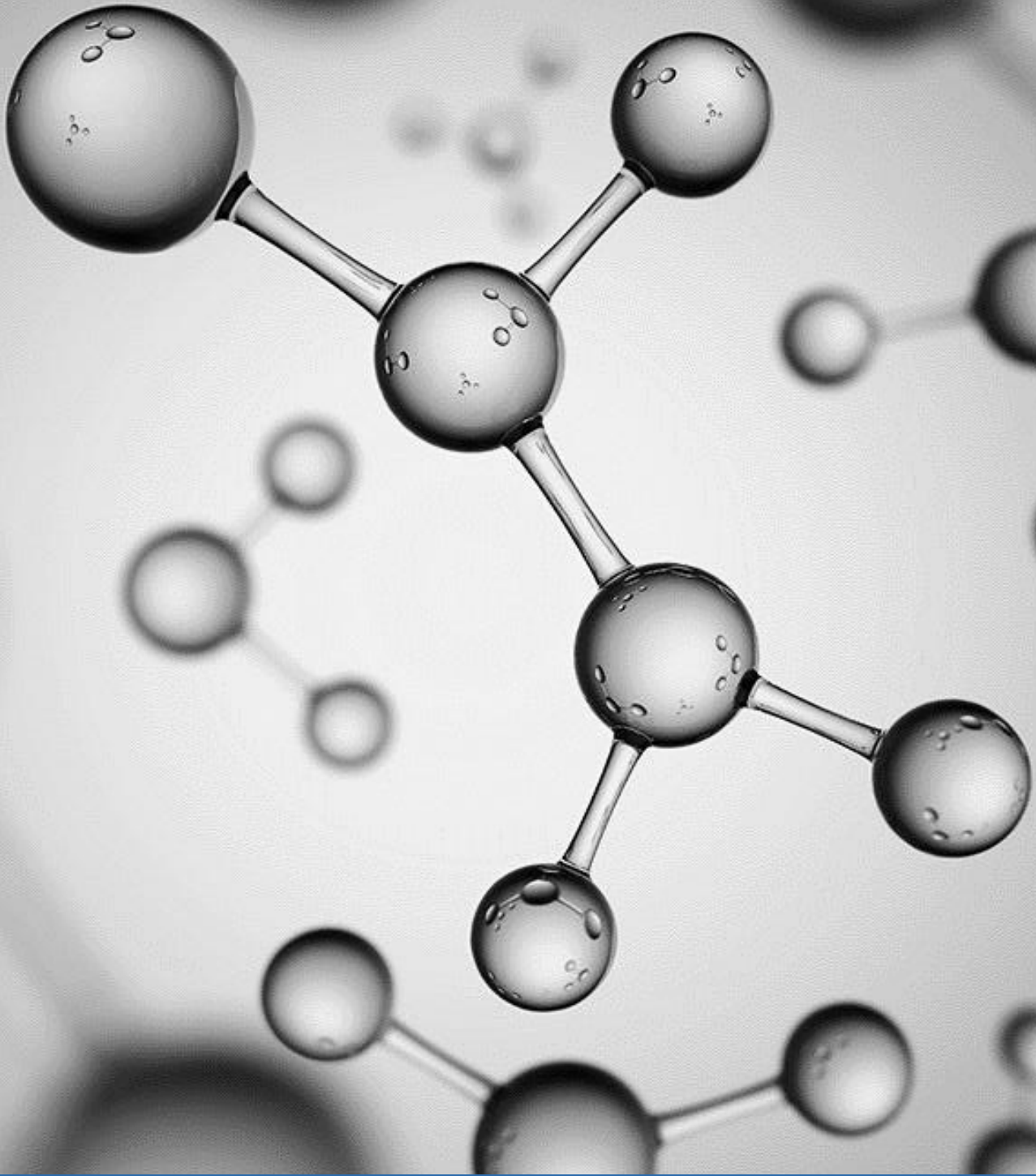

06

ARCHITECTURAL GUIDELINES

6.1 General Finishes

Acoustic, maintenance and durability considerations are the primary concerns in finishes for laboratories. Sound transmission classification (STC) ratings of structural components and finishes should be taken into consideration when selecting materials and systems. Interior finishes shall contain low or no Volatile Organic Compounds (VOC), and to the greatest extent possible be obtained to achieve the Leadership in Energy and Environmental Design (LEED) credit for local sourcing. Materials shall to the greatest extent possible contain recycled content, be recyclable, be sustainably produced and meet cradle-to-cradle standards. Examples include recycled steel, ceiling tiles, and wallboard as well as rubber flooring. Rapidly renewable materials shall also be considered where suitable. In cases where corrosive chemicals are in heavy use, all laboratory finishes chemical resistances should be cross referenced with expected chemical use in the lab to insure minimal corrosion.

6.1.1 Walls and Doors

- Designers are to select materials that allow for normal cleaning, upkeep, and maintenance.
- Wall and corner protection shall be provided where cart or equipment traffic occurs regularly.
- Doors into laboratories shall be provided with fire-rated vision panels (to observe whether the laboratory is in use), self-closing door hardware and kick plates.

6.1.2 Floors

- Wet chemical laboratories shall have chemically resistant flooring.
- Floors shall be level, and non-slip.
- Floor drains shall only be installed based on a demonstrated engineering need. Where floor drains are indicated, they must be outfitted with a trap seal primer to prevent the escape of sewer gas.
- Finished flooring shall be installed throughout the laboratory to accommodate flexible laboratory conditions and room modifications.
- Floors shall have a minimum 4-inch high cove base.
- Where an integral continuous base is not provided, a continuous bead of sealant will be provided between wall plates and floors.
- If needed, conductive tile shall be set in approved conductive adhesive and provided with an appropriate grounding strip for connection to an external ground. Ground connection to an external ground shall be indicated. Conductive flooring shall be provided with a conductive cove base. Special cleaning and maintenance requirements shall be specified.

6.1.3 Ceilings

- Concern for proper acoustics and access to valves and equipment shall prevail in selection of ceiling materials.
- No concealed-spline ceilings shall be utilized.
- Seal joints at suspended ceiling perimeters and transitions with hard construction.
- Suspended ceilings shall be designed to avoid narrow or sliver panels, and unequal placement of panels on perimeter.
- Wet areas, Vivarium, or other special lab areas shall have hard, painted gypsum board, fiber reinforced panel (FRP) or other special ceiling systems that provide compliance with Association for Assessment & Accreditation of Laboratory Animal Care (AAALAC), Good Laboratory Practice (GLP) or Good Manufacturing Practice (GMP) requirements as applicable. Retaining clips shall be provided where required.
- Access panels as determined by Facilities Operations and/or Engineering shall be provided to sufficiently access all volume dampers, fire and smoke dampers, valves and equipment for maintenance and repair.

6.1.4 Window Treatment

- Review need for sunlight filtering in laboratories; 1% to 3% openness of roller shades is generally recommended. Standard room darkening shades may be manual or motorized.
- Room Darkening vs. Solar Controls - Solar controls to support the HVAC needs must be considered for both the exterior and interior of the laboratory space in new construction.
- See building specific standards in Section 122413 of Design Requirements

6.2 Casework

- Work surfaces shall be chemical resistant, smooth, and readily cleanable. Back and side splashes shall be provided along the perimeter of lab benches. Transitions from standing to sitting height benches shall have work surface transition for continuous chemical resistant surfaces for wet labs.
- Filler Panels shall be provided at all inside corners to allow for smooth, full open door and drawer operation.
- Work surfaces, including computer areas, shall incorporate ergonomic features, such as adjustability, task and day lighting and equipment layout.
- Bench work areas shall have knee space to allow room for chairs near fixed instruments, equipment or for procedures requiring prolonged operation.
- Cup sinks on bench tops shall be installed only after the determination of specific research needs based on consultation among the end user and EH&S. If approved, a lip must be installed around the basin perimeter to prevent inadvertent release of spilled material into the drain. Cup sinks shall be outfitted with a trap seal primer to prevent the escape of sewer gas.
- Open shelving must be designed so that maximum shelf height is no closer than 36 inches from the ceiling to maintain a minimum of 18 inches clear above stored items.
- Epoxy resin countertops are standard in biology and chemistry labs. Use of countertops of other materials are subject to review and approval by CPM.

6.3 Furniture

Furniture shall be scheduled to the extent possible with standardized dimensions and parts and in compliance with university-wide campus standards.

6.4 Lighting

6.4.1 General

See Columbia University Facilities Design Requirements, Sections 265000 and 265000S.

- Daylighting shall be maximized where possible for user comfort. Lighting shall be even across the room, with a maintained light level capable of 75 foot-candles on the work surface. Non-laboratory space shall follow Illuminating Engineering Society (IES) standards. A combination of lighting zones, dimmable fixtures, and controlled daylight and occupancy sensors with adjustable sensitivity in the room is ideal.
- Much of the public space lighting on the University campus is controlled by occupancy sensors. Typically, at least one light in a space will be on an emergency circuit or per building code whichever is more stringent.
- Ceiling mounted ultrasonic sensors (or better) shall be used in corridors to turn off lights. Infrared sensors should be used in areas where animals are housed or transported. Select fixtures shall remain "on" at all times in sufficient quantity to maintain a minimum of 2 foot candles for security and safety. (It is the intent that these select fixtures be part of the emergency generator-powered emergency egress lights, rather than a set of additional fixtures.)
- Lighting fixtures should not be placed where they will obstruct or interfere with the spray pattern of sprinkler heads. (Refer to NFPA 13).

6.4.2 Lighting Types

- Fixtures with Light-Emitting Diodes (LED) are standard for the University. Indirect/direct lighting is preferred for its even quality, however, should only be considered when ceiling height is adequate (9'-6" minimum). For any needed down lighting or highlighting, a compact LED fixture should be utilized.
- In public spaces or where special lighting is required, the design team may submit alternate lighting systems to the CUFO or CUIMC CPM for review and approval.

6.5 Storage/Disposal: Hazardous Waste

See Columbia University Research Environmental Health and Safety Handbook, Chapter 5 Section I.

- NYC campuses must adhere to NYC Building Code, NYC Fire Code, and NFPA 45. The design team is responsible to confirm all hazard, code and regulatory issues that apply to the design of the project and be coordinated and approved by EH&S, and CUFO or CUIMC CPM.

- Minimum code required clearances for sprinklers shall be maintained. Explosion-proof or flammable-proof refrigerators shall be used where flammable materials are stored.
- Explosion-proof hoods, equipment, finishes, systems, etc. shall be designed and specified where required by applicable codes.
- Chemical storage is not permitted underneath sinks; prohibition labels shall be affixed to the cabinets.
- Cabinets for chemical storage shall be of solid, sturdy construction, with built-in partition for separation of incompatible chemicals for secondary containment and vented as required by applicable code.
- Flammable gas or liquid storage, use or dispensing is not permitted below grade or near a means of egress.
- Storage of corrosive chemicals (acids and bases) shall be so arranged that there will be no contact with (and physically distant from) bare unprotected metals or casework, even when sealed. Storage cabinets for corrosive materials must be poly-lined and protected. Additionally, oxidizing acids cannot be stored on cellulosic material.
- Laboratories which operate High Performance Liquid Chromatography (HPLC) or related equipment must have a workstation which is designed so that waste containers are not stored on the floor.
- Laboratories using compressed gases should have areas designated for cylinder storage and be equipped with devices to secure cylinders in place. Cylinders must not be secured to plumbing or electrical conduits. Cylinder Manifold systems shall be designed to be readily accessible for FDNY inspection and have required permit information readily available.
- Flammable Storage Cabinets whether stand alone or incorporated under chemical fume hoods are suggested as flammable limits are allowed to be increased (or doubled) with the presence of a Flammable Storage Cabinet in a laboratory

6.6 Storage/Disposal: Regulated Medical Waste
See Columbia University Regulated Medical Waste Plan

- Adequate storage/staging shall be provided for containers awaiting removal and for an adequate reserve.
- Sites where Regulated Medical Waste (RMW) is staged prior to pick up shall incorporate the following features:
 - Protection from the environment and limitation of exposure to the public.
 - RMW must be maintained in a non-putrescent state, using refrigeration, if necessary.
 - Storage areas shall be provided with locks to prevent unauthorized access.
 - The design team shall be responsible to provide a vermin control specification that meets the applicable institutional, NYS-DOH, and NYS-DEC requirements.

6.7 Acoustic and Vibration

The design team must consider maximum acceptable noise and vibration criteria in each equipment selection, location, and system design and discuss those considerations with CUF or CUMC CPM.

The design team must incorporate appropriate noise and vibration control devices.

6.8 Signage

Laboratory signage within New York City shall be provided by means of the standard EH&S "Laboratory Door Sign," (See Columbia University Research Environmental Health and Safety Handbook Annex III-B). The sign shall be placed adjacent to the latch side of the door leading to the laboratory located at the mid-point of the height of the door in accordance with NYC Code requirements. See Appendices 11.5 and 11.8.

6.8.1 Place additional safety signage as required and appropriate, in accordance with applicable standards.



07

MEP GUIDELINES FOR LABORATORY DESIGN

7.1 MEP Design Considerations

7.1.1 General

Overall, MEP distribution shall be based on a modular layout. Systems shall be designed to ensure reliability, maximize operational flexibility and capacity for renovation, allow service to occur without interfering with research, and to minimize potential for disruption due to single point failures and routine maintenance.

A primary goal for distribution systems is to minimize floor penetrations in laboratory areas.

A/E shall utilize efficient capacity methods for sizing primary equipment to provide required redundancy and overage while maintaining energy efficient operation for the normal operating load profile.

Early planning and coordination with the entire design team is critical and close coordination between mechanical, electrical, and structural disciplines is required to minimize interference of piping/ventilating systems and electrical systems, with structural framing.

Whenever connections are made into existing systems to serve new equipment, additions, or renovated areas, the A/E and Facilities shall analyze the existing system to confirm available capacity.

The design shall carefully consider cost effective approaches that shall result in economical arrangements of MEP services including risers, mains, branches, run outs for both valving and circuiting arrangements that allow for shutdown of individual laboratories, as well as independent isolation of each floor, building wing, and zone without affecting other areas.

Space shall be provided for accessibility to permit modifications and maintenance to the system. Equipment shall include, but not be limited to, valves, cleanouts, motors, controllers, and drain points, etc. Where required, access doors or panels shall be provided.

MEP materials and methods shall be compatible with system application. The selection of materials and installation methods shall incorporate special requirements unique to individual program areas, such as consideration of magnetic fields, special materials, shielding, also all types of chemical exposure etc. in accordance with equipment and functional operation requirements.

In existing facilities renovated to accommodate a new lab program, the A/E shall specify sealing existing penetrations.

Utility metering shall be provided for primary utility services, capable of automatically registering peak flow (process and comfort) and totalization to the building automation utility monitoring systems to the extent possible for all new buildings. Submetering of utilities (electric, process chilled water, comfort chilled water, comfort hot water) for renovation projects shall be discussed with CU Facilities to confirm if it is feasible and necessary. The A/E shall coordinate all metering requirements with CU Facilities during the early schematic design phase of the project.

Equipment and piping installations shall be designed to preclude noise and vibration transfer beyond referenced limits, including but not limited to use of resilient supports, vibration dampening equipment bases, flexible connectors or braided hoses as appropriate, and other considerations as required for the intended operation of the facility and to avoid negatively impacting the research activities.

Heat recovery systems shall be utilized unless analysis demonstrates non- feasibility.

The design team shall coordinate with the CU Facilities team and complete the Utility Data Sheet (UDS) indicating the annual increase in steam, chilled water, electricity, potable water and sewer usage.

The lab equipment list, with all required MEP services, shall be created during the programming phase. The lab equipment list shall be revised, as required, during all subsequent design phases.

7.1.2 Design Conditions

7.1.2.1 Indoor Design Conditions

Temperature and humidity set points and tolerances shall be confirmed during concept design.

Refer to CU Design Guidelines Section 00 00 14 Design Requirements for additional information.

7.1.2.2 Summer Outdoor Design Conditions

Research facilities where mechanical systems are being greatly modified shall be designed for 92° F Dry bulb, 74° F Wet bulb. Open cell cooling towers shall be designed for 78 ° F Wet bulb. Evaporative condensing units shall be designed for 105° F ambient.

7.1.3 Critical Environmental Spaces (Based on Temperature and Humidity)

Critical environment spaces shall be served from a dedicated cooling system. The need for redundancy shall be evaluated by the A/E and CU. The components included in redundancy shall include, but not limited to the following:

- Cooling
- Heating
- Humidification
- Power

The cost associated with the redundant systems shall be evaluated by the A/E and CU and the scope of work will be confirmed in Schematic Design.

7.1.4 Dedicated (Year-Round) Chilled Water

Dedicated chilled water refers to year round, 24/7, chilled water used to cool lab spaces and occupants (environmental comfort). It is a University goal to minimize the production of all central plant chilled water, particularly dedicated chilled water. The use of air side economizers is encouraged for environmental comfort where practical. All proposed uses of dedicated chilled water require approval from Plant Engineering (or applicable campus facilities at Nevis and Lamont Doherty). Where that need is established, Plant Engineering will evaluate if the existing building infrastructure has the capacity to support the additional load. When infrastructure upgrades are required, it is intended that they be performed on a building wide basis and include forecasted load growth.

7.1.5 Process Chilled Water

Process chilled water refers to chilled water used to cool critical and non critical lab equipment. Process chilled water systems generally operate year round, 24/7. All new and substantially renovated science buildings are required to provide process chilled water systems to serve these needs and include a realistic building growth factor. Process chilled water systems shall be designed in a manner that allows expansion of the system with minimal disruption to the building. Roof and mechanical space shall be reserved to install additional chillers, pumps and ancillary equipment. Process chilled water systems should be designed with 100% redundancy. Connection of laboratory equipment to the process chilled water loop shall be through a heat exchanger which hydraulically isolates the loop from the equipment.

The use of centralized campus chilled water to cool laboratory equipment must be reviewed and approved by CU Facilities.

The use of domestic water to cool laboratory equipment is prohibited.

7.2 Mechanical and Ventilation/Exhaust

7.2.1 Existing Air/Water Testing

The A/E team shall prepare a testing scope of the existing system to be completed by a Testing and Balancing Contractor (TAB). The scope of work shall include, but not limited to:

- Equipment locations
- Operating points to be tested (i.e. CFM, static pressure, fan/pump speed, motor amperage, entering/mixed/leaving air temperatures, supply/return CHW/HW/Process water temperatures and flows)
- Duct traverse locations
- Air device locations
- Associated highlighted existing plans, when available, or sketches

The design team shall review, analyze, and incorporate testing data into the design.

7.2.2 Ventilation

All laboratories shall have mechanical ventilation, the use of operable windows is prohibited. Laboratory ventilation systems shall be designed to operate 24 hours per day, 7 days per week with a minimum of six (6) air changes per hour (ACH). Animal Satellite Facilities must be provided with 10-15 ACH.

7.2.3 Exhaust

All laboratories shall be exhausted to the outside. Design to maintain negative pressure relative to adjacent non-lab areas. The pressure relationship between all laboratory spaces shall be reviewed with the Researcher and CU Facilities

7.3 Building Automation System (BAS)

7.3.1 Commercial Grade

The Morningside campus has standardized on Andover Controls and Siemens Building Technologies as the acceptable manufacturers for building automation systems (the system manufacturer will be based on the existing BAS system installed within the building). The Medical Center campus has standardized Johnson Controls and no other system shall be considered for approval without CUIMC Facilities Operations/Engineering. The Lamont-Doherty campus has standardized on Siemens as the acceptable manufacturer for building automation systems. The Manhattanville Campus has standardized on Andover Controls and Siemens Building Technologies as the acceptable manufacturers for building automation systems (the system manufacturer will be based on the existing BAS system installed within the building).

The BAS is to be configured as a network with workstations, file servers, field controllers and necessary interfacing controls. Field controllers shall have the ability for local control in the event of a network outage.

All operator devices shall have the ability to access all point status and application report data or execute control functions for any and all other devices, via the local area network.

Communication between all Direct Digital Control (DDC) units, servers and the workstations shall be by way of high speed network communication cable utilizing Ethernet that is coordinated with Columbia Universities' IT (CUIT) department.

As program requires, optional stand-by power should be provided for the entire DDC system.

All DDC software must be web enabled for remote communications.

Where laboratory variable volume systems are specified in new and substantially renovated science buildings they shall be furnished with a stand-alone DDC electronic controllers, pressure independent, variable air volume laboratory flow tracking system.

The flow tracking system includes VAV and/or CAV boxes, reheat coils, damper and valve operators, with all control devices to monitor the following as minimum: room temperature, °F, room humidity, % RH, reheat coil valve position, reheat coil temperature °F, supply cfm, exhaust cfm

For renovation work in existing buildings the existing Building Automation System (BAS) shall be utilized. The capacity of the existing BAS to incorporate additional control points shall be verified with CU Facilities. A second system should not be installed. Provisions for future expansion shall be made as determined by CU Facilities on a project-by-project basis.

7.3.2 Industrial Grade

Critical environments are spaces with temperature requirements more stringent than +/-2F and/or humidity requirements more stringent than +/-5% RH. Critical environments shall be provided with a Supervisory Control and Data Acquisition (SCADA) industrial control system.

All points on the SCADA system will be viewable on the BAS.

Refer to CU Design Requirements for additional information.

7.3.3 Minimum BMS Points to be Connected to BAS

The quantity and type of control points to be provided shall be reviewed with CU Facilities.

At a minimum the following controls points shall be provided:

Air Handling Units	
Outside Air Damper	Control Position
Return Air Damper	Control Position

Exhaust Air Damper	Control Position
Mixed Air Temperature	
Filter Alarm	
Freeze Stat	
Heating Coil	Control Valve Position Control Valve Control Discharge Air Temperature Entering/Leaving Water Temperature
Cooling Coil	Control Valve Position Control Valve Control Discharge Air Temperature Entering/Leaving Water Temperature
Low Pressure Inlet	
High Pressure Outlet	
Supply Air Temperature	
Supply Air Relative Humidity	
Return Air Relative Humidity	
Water Detection in Aux Drain Pan	
Fans	
Start/Stop	
Status	
Fault	
Speed Control (if applicable)	
Low Pressure Inlet	
High Pressure Outlet	
Variable Air Volume (VAV)/Constant Volume (CV) terminal boxes	
Air Flow	
Damper Position	
Damper Control	
Supply Air Temperature	
Fan Coil Units	
Start/Stop	
Status	
Control Valve Position	
Control Valve Control	
Discharge Air Temperature	
Water Detection in Aux Drain Pan	

Pumps

Start/Stop

Status

Fault

Speed Control (if applicable)

Heat Exchangers

Primary Side

Water Flow

Supply Water Temperature

Return Water Temperature

Control Valve Position

Control Valve Control

Secondary Side

Water Flow

Supply Water Temperature

Return Water Temperature

Control Valve Position

Control Valve Control

Humidifiers

Start/Stop

Status

Fault

High Humidity Alarm (in discharge ductwork)

Enthalpy Wheel

Start/Stop

Status

Speed Control

Fault

Variable Frequency Drives

Start/Stop

Status

Speed Control

Fault

Spaces

Temperature

Relative Humidity

7.3.4 Lab Equipment Integration

The quantity and type of monitoring points to be integrated into the BAS shall be verified with the Researcher and CU Facilities. All required gateways and control modules shall be provided.

An environmental monitoring and security system shall be provided to monitor critical equipment such as freezers, designated environmental rooms, cabinets, and other types of equipment as indicated in the lab program. This system shall be interfaced with the BAS system to provide emergency alarm/reporting only.

7.4 Electrical

7.4.1 General

Laboratories should have a sufficient number of electrical outlets to eliminate the need of extension cords and multi-plug adapters. Electric outlets quantities/types/locations should be coordinated with the electrical characteristics of the lab equipment and the Researcher.

Each laboratory in a major renovation shall have a dedicated panel board located in an unobstructed accessible area preferably adjacent to the lab door, labeled with the room number. Or, if panels are centrally located, they must be on the same floor, labeled with the room number(s) they are serving. All electrical outlets and dedicated shut-off switches shall have a label on the cover plate with the corresponding panel and circuit number they are energized from. Laser laboratories shall have an emergency shut-off switch installed near the entrance of the laboratory to turn off the laser remotely.

Smaller, plug-in type UPS and power conditioners are the responsibility of the end use. Larger, hard-wired systems are the responsibility of the project.

Each electrical panel board shall be provided with a panel number marked (at the exterior panel face) that is coordinated with the panel board schedules on the electrical construction drawings.

The AE shall determine in conjunction with information from the researcher if an isolating grounding system is required for the design of the project and, as required, coordinate with Facilities to avoid potential conflicts.

7.4.2 Normal and Optional Stand-by Power

7.4.2.1 Existing Electrical Testing (Normal and Optional Stand-by Power)

The A/E team shall prepare a testing scope of the existing system to be completed by a CU Facilities or the Electrical Contractor. The scope of work shall include, but not limited to:

- Panel locations

7.4.2.2 Normal

In new construction, the electrical service is to be extended from the main service switchboards to distribution panels located in electric closets on each floor. These local floor panels will serve the interior floor distributions system as described below:

- Sensitive equipment and laboratory loads shall be segregated from large motor loads
- Lighting loads shall be segregated from other loads and an individual panel on each floor.
- The interior distribution system to each lab shall also include as a minimum dedicated 120/208 V, 3 phase, 4 wire plus ground panel boards, 150-amp main circuit breaker with forty-two (42) branch circuit breakers. Each panel will be door-in-door construction with copper bus bars (no aluminum) and an integral digital meter (3 phase amps and volts) and integral Transient Voltage Surge Suppressor (TVSS). These panels which are also typically located in the lab to serve lab convenience outlets, lab equipment, etc. Space in each electric closet should be reserved for future panel boards. Vivarium lighting, equipment and convenience outlets shall be served from separate dedicated panels located in each electric closet and 120/208V distribution system.

7.4.2.3 Optional Stand-by

Optional Stand-by power shall only be derived from the building emergency power distribution system, not from adjacent buildings.

An Optional Stand-by power load study is required for all new laboratories where applicable.

Optional Stand-by power distribution shall be considered as required to serve the following equipment and loads as a minimum: domestic water system, environmental rooms, critical equipment, refrigerator, freezers, cold rooms, etc., critical laboratory equipment and their required support systems, one circuit per lab module for discretionary convenience receptacle, fume hoods and their exhaust and makeup air systems, 33% of lighting in laboratories, procedure rooms, and equipment areas, equipment and communications technology power distribution systems, entire animal facilities.

7.4.3 Fire Alarm

The Morningside campus has standardized on Siemens XLS as the acceptable manufacturers for fire alarm system (the system manufacturer will be based on the existing fire alarm system installed within the building). The Medical Center campus has standardized on Edwards. The Lamont-Doherty campus has standardized on Seimens XLS. The Manhattanville Campus has standardized on Edwards.

The Nevis campus has the following systems:

- Press - Bosch Fire Control Panel / Fire Shield Plus / Alarm Path Communication Device
- Mansion – Bosch Fire Control Panel / Silent Night Honeywell / Alarm Path Communication Device
- Research – Bosch Fire Control Panel / Fire Alarm Panel (Edwards Co. Norwalk Conn.) / Fire Alarm Circuit (Pyrotronics LLP-3A) / Alarm Path Communication Device
- Lower Lab Radionics Fire Control Panel / Advanced
- RARAF – Bosch Fire Control Panel / Siemens MXL-IQ / Ademco Fire Alarm Control / Honeywell Fire Detection / Pyrotronics LLP-3A
- Carriage House – Radionics Fire Control Panel / Silent Night Honeywell SK-2 / Kidde ATMO Automatic Fire Alarm System

For existing fire alarm systems that remain at Morningside and Medical Center campuses, the following shall be confirmed with CU:

- Certificate of occupancy issued by the DOB
- Letter of deficiency (LOD) issued by the FDNY
- Notice of defect (NOD) issued by the FDNY
- Letter of approval (LOA) for the base building system issued by the FDNY
- Will the project have a change in occupancy type
- Quantity of available points

If the existing fire alarm system is not approved, it shall be reviewed with CU whether a fire alarm expeditor is retained.

An integrated fire alarm, smoke detection and sprinkler alarm system shall be provided.

The system shall be a fully addressable distributed processing topology providing alarm and communication features to a central processor.

All detectors shall be addressable and self-testing.

Provide photoelectric type for area detection and ionization type for duct mounting.

Smoke detectors shall be considered in all laboratory modules.

The wiring protocol of all fire alarm devices, including combination fire smoke dampers, shall be reviewed with CU Facilities.

The sequence of operation associated with the shutdown and reset procedure of HVAC systems serving critical environments shall be reviewed with the CU and the researcher.

At Lamont Doherty and Nevis campuses comply with local requirements.

7.4.4 Lighting Controls

The lighting control zoning and sequence of operation shall be reviewed with the Researcher and CU Facilities.

Additional automatic/manual lighting control overrides may be required based on the research type.

Refer to CU Design Guidelines Section 01 30 00 Design Requirements for additional information.

7.5 Plumbing

7.5.1 General

Building services to the extent possible (such as centralized bottled gases, Reverse Osmosis Deionized (RODI) water and compressed air required for research), shall be considered in the design to facilitate modular systems and services for the facility.

Manifolding gases and decentralizing some services shall be evaluated as required to accommodate the addition of future loads on a project-by- project basis.

Piping above major electrical, telecommunications, or other critical equipment rooms (including service access for such items) should be avoided where possible.

Isolation valves shall be provided to accommodate maintenance at each module, laboratory, group of toilet rooms, or program suite where routine service shall be required without affecting other areas. Isolation valves shall be accessible and located on the floor being served.

All valves shall be clearly identified (labeled/tagged) and correspond to the facility valve numbering and identification system, keyed to submitted charts. Drains shall be provided at the base of all water risers and include National Pipe Threads (NPT) threads, valve, and cap.

All utility pipelines shall be clearly labeled to identify the service provided and direction of flow within each module.

In installations where gas is piped throughout the building, provide emergency laboratory isolation valves outside of each lab. Panic buttons may be considered for natural gas lines.

Use flexible connections for connecting gas and other plumbing utilities to any freestanding device.

The quantity/location of chemicals shall be reviewed with the Researcher and CU to determine if a Lab Permit is required. The existing Lab Permit issued by the FDNY (or

applicable local code/AHJ for Nevis and Lamont Doherty) may need to be revised based on the new space requirements.

7.5.2 Gas Cylinders

When compressed gas cylinders are required inside a laboratory, the following conditions shall apply:

- Provide strapping and anchoring devices to a permanent building member. The number of devices shall be adequate for the number of cylinders, bearing in mind that local regulations may restrict the number of cylinders of an individual gas permitted to be stored in a laboratory. The cylinder restraint system is subject to the review and approval of both Facilities and EH&S.
- The storage site shall be protected from heat sources. The site shall be in area that minimizes that opportunity for accidental contact with the cylinders. The site shall be in a well ventilated, dry location, with easy accessibility for periodic exchange of cylinders.
- Gas cylinders shall not be stored in an unprotected in public corridors. Cylinders may be stored in properly constructed corridor storage closets with proper wall ratings, ventilation and monitor equipment.
- Confirm oxygen sensor requirements with EH&S.
- Confirm with the researcher how/when cylinders will be replaced. An automatic/manual manifold system may be required.

7.5.3 Water Treatment

Provide acid neutralization and any other treatment of water sent to a Publicly Owned Treatment Works (POTW) as per all applicable laws and regulations.

Provide storage space for spill prevention materials in each laboratory.

Use water treatment systems that comply with the following criteria:

- For buildings with a Building Management System (BMS) system, all filtration processes, remote notification shall be provided (by means of BMS) along with local pressure gauges to determine and display when to backwash or change cartridges.
- For all ion exchange and softening processes, recharge cycles shall be set by volume of water treated or based upon conductivity or hardness.
- For reverse osmosis and nanofiltration equipment, with capacity greater than 100 liter/hr., reject water shall not exceed 60 % of the feed water.
- Simple distillation is not acceptable as a base system for water purification.

7.5.4 Vacuum Pumps

Vacuum pumps shall be used in lieu of aspirators.

Vacuum systems shall not be provided as a centralized system unless authorized by CUF based on a demonstrated research need, and following consultation between the end-user, Project Manager, and EH&S. Provisions shall be made to appropriately vent exhaust individual vacuum pumps.

7.6 Fire Protection

7.6.1 General

A central combined fire standpipe/sprinkler system is to be provided for all buildings on the Campus.

For projects where an existing fire protection system has not been installed, the addition of a new fire protection system shall be confirmed with CU.

Pre-action sprinkler systems should be given consideration for specialized imaging equipment and IT server rooms.

Schedule 40 piping shall be specified. Schedule 10 and other thin wall piping are not permitted.

Refer to CU Design Guidelines Section 21 00 00 Design Requirements for additional information.



08

SAFETY AND SECURITY GUIDELINES

8.1 General

- Utility shut-off controls should be located outside the laboratory.
- Environmental chambers where evacuation or other alarms cannot be heard shall be equipped with strobe lighting or additional alarms.
- The requirements for monitoring and control of laboratories using toxic gases shall be reviewed with EH&S

8.2 Eyewash Standard

Refer to Appendix 11.5

8.3 Biological Safety

Laboratory spaces for work with biological materials shall incorporate the following features:

- Self-closing doors.
- Sinks for hand washing.
- Wall, floor and working surfaces designed to be easily cleaned. Carpets and rugs are not permitted.
- Bench tops impervious to water and resistant to heat, organic solvents, acids, alkalis, and other chemicals.
- Spaces between benches, cabinets, and equipment accessible for cleaning.
- Chairs covered with a non-porous material that can be easily cleaned and decontaminated.
- Biological safety cabinets (BSC) installed in such a manner that fluctuations of the room supply and exhaust air do not cause the BSCs to operate outside their parameters for containment. Locate BSCs away from doors, windows that can be opened, heavily traveled laboratory areas, and from other possible airflow disruptions.
- HEPA filtered exhaust air from a Class II Biological Safety Cabinet may be recirculated back into the laboratory environment. Connection to the laboratory's exhaust system must be approved by EH&S and must be by means of a canopy and not a hard connection.
- The BSC class to be reviewed and confirmed with EH&S.

8.4 Fire and Life Safety

8.4.1 Fire Suppression Systems

- Sprinkler Systems - Laboratories shall be provided throughout with an automatic sprinkler system in accordance with NYC Building Code, or applicable local code/AHJ for Nevis and Lamont Doherty.
- Standpipe System - standpipes shall be installed in accordance with NYC Building Code, or applicable local code/AHJ for Nevis and Lamont Doherty.

- Refer to section 7 of the Lab Design Guidelines and CU Design Guidelines Section 21 00 00 Design Requirements for additional information.

8.4.2 Laboratory Units

- In accordance with NFPA 45, NYC Building and Fire Codes, or applicable local code/AHJ for Nevis and Lamont Doherty.
- Storage Limits - Flammable and combustible liquids. The density and total quantity of flammable and combustible liquids allowed within a laboratory unit, excluding storage rooms, shall be in accordance with NFPA 45 for laboratory unit fire hazard classes B and D. EH&S shall be consulted regarding flammable chemical quantity limits in order to validate the minimum code fire rating.
- The quantity/location of chemicals shall be reviewed with the Researcher and CU to determine if a Lab Permit is required. The existing Lab Permit issued by the FDNY may need to be revised based on the new space requirements.

8.4.3 Chemical Storage Rooms

In addition to the quantities that may be stored, handled and used in a laboratory, chemicals may be stored in a dedicated storage room (up to 300 Gallons). Such rooms may enhance the efficiency of laboratory operations and should be considered if space considerations allow. Consult with EH&S for specific requirements.

8.4.4 Oxygen (O₂) Sensors

Where sensors are or may be required by code, consult EH&S regarding the selection of the oxygen sensor and its installation location.

8.4.5 Black-out/Laser Curtains

EHS should be consulted to confirm the need for black-out/laser curtains, the type that should be specified, and other requirements. Curtains are required to be made of an inherently flame-resistant material (IFR). These curtains require documentation from the manufacture stating they are in compliance with NFPA 701. These curtains must also be tested, and documentation issued by a FDNY Certificate of Fitness holder (or applicable local code/AHJ requirement for Nevis and Lamont Doherty) for Flame Retardant Treatment C-15 to their flame resistance. Copies of both documents must be provided to EH&S.

8.4.6 Fire Blankets

EHS should be consulted regarding the need for fire blankets.

8.4.7 Fire Extinguishers

10-pound ABC extinguishers (or other appropriate type extinguisher) shall be installed in accordance with NFPA and NYC Fire Codes (or applicable local code/AHJ requirement for Nevis and Lamont Doherty). Fire extinguishers shall be placed in external cabinets which are identifiable by proper signage. Fire extinguishers shall be located near (within 10 ft.) of main entrance doors. Maximum travel distance to any extinguisher must be within 50 ft.

Consult EHS-Fire Safety to determine the type of extinguishers required.

- 8.5 Security
The A/E shall review security requirements with the Principal Investigator, Project Manager and Public Safety. The University employs access control (e.g., Lenel Systems), as part of a campus-wide system, at the entrances of many of its buildings, and to some interior spaces as well.
- 8.6 Radiation Safety
The A/E shall review safety requirements with the Principal Investigator, Project Manager and EH&S. Refer to Laboratory Ventilation and Fume Hood Exhaust Systems section of the Lab Design Guidelines for additional information. Radiation signage, area or portal radiation detectors, and structural shielding may be required.
- 8.7 Laser Safety
The A/E shall review safety requirements with the Principal Investigator, Project Manager and EH&S. "Laser in Operation" signage and emergency power off (EPO) pushbutton(s) may be required.
- 8.8 Compressed Gases
The A/E shall review safety requirements with the Principal Investigator, Project Manager and EH&S. O₂ sensors and venting may be required.
- 8.9 Electromagnetic Fields
The A/E shall review safety requirements with the Principal Investigator, Project Manager and EH&S. Laboratories with high field strength magnetic fields (e.g., containing NMR or MRI devices) where accessible areas may exceed a magnetic field of 0.5 mT (5 gauss) may require appropriate door signage and other markings. Radiofrequency equipment greater than 30 kHz (e.g., RADAR equipment, microwave transmission, etc.) may require engineering controls to limit accessible fields below the MPE.



09

CUIT/CUFO IT REQUIREMENTS

9.1 CUIT/CUFO IT Design Considerations

9.1.1 General

In general, junction boxes and pathways in walls and inaccessible ceilings will be provided by the A/E team. Wiring and equipment will be provided by CUIT. Scope of work for all parties shall be confirmed with CU CPM and CUFO IT.

CUIT and CUFO IT shall confirm all security requirements associated with the connection of the BMS.

Refer to CUIT Design Guidelines for additional information.



10

SPECIAL ROOMS AND EQUIPMENT

10.1 Environmental Rooms

Custom fabricated units to meet programmatic requirements and fit in allocated space. Unless specifically approved otherwise, environmental rooms are for storage and for procedures of short duration. If approved long term procedures are to be conducted, ventilation must be provided. The need for ventilation should be reviewed with EHS.

Environmental Rooms may be constant or variable temperature, cold rooms, or warm rooms. These rooms shall be located to accommodate maintenance and visual monitoring from outside the room space. Environmental rooms that require ventilation shall be ventilated as per manufacturer's guidelines.

Environmental rooms shall be fed by processed chilled water systems if available.

10.2 Biosafety Level 2 Laboratories

All laboratories where biological materials will be used are to be designed to BSL2 requirements. See Section 8.3 and the publication, available online, CDC/NIH Biosafety in Microbiological and Biomedical Laboratories, latest edition.

10.3 Imaging/Microscopy Rooms

In the case of technically complex imaging/microscopy equipment (confocal and electron microscopes, etc.) the design team must determine through discussions with the principal investigator what specific instrument(s) will be utilized and obtain location and installation requirements for those instruments(s) from the principal investigator or manufacturer.

10.4 Equipment Rooms

A room for storage of numerous pieces of large equipment (e.g., -80° freezers, large centrifuges, etc.). Due to the substantial heat load of this equipment, supplemental cooling is likely to be required and should be carefully considered by the design team. The equipment list developed through survey by the design team and discussion with the principal investigator will identify space and utility requirements for these spaces. The possible need for acoustical mitigation of rooms containing equipment should be reviewed by the design team.

10.5 Fume Hood Alcoves

Fume hoods must be located such that air currents associated with circulation of lab occupants, etc., does not interfere with exhaust capture. For this reason, the design team should consider creation of fume hood alcoves off open plan lab areas, rather than locating hoods within the open plan lab. Centrally locating these alcoves will facilitate the sharing and possible reduction of the number of hoods.

Note: cupsinks are not to be provided in fume hoods unless specifically reviewed and approved by EHS.

- 10.6 Cell/Tissue Culture Rooms
These rooms must be designed to maintain sterile conditions through use of biological safety cabinets (see 3.5), easily cleanable finishes and services, lensed and gasketed light fixtures. These rooms should be located internal to lab spaces rather than off public corridors or in other places where negative space pressurization is required.
- 10.7 Glasswash Rooms
These rooms may contain one or more autoclave(s), as well as glassware washers, ice machines and other large equipment. The design team must obtain product information on specific pieces of equipment to properly allocate space, provide necessary services and design the mechanical system. One or more floor drains will be required, and resinous flooring should be provided. Due to the heat and humidity generated by this equipment it is likely that supplemental cooling and exhaust will be required.
- 10.8 Clean Rooms
Spaces where particulate matter would compromise the work product (semiconductors, etc.). These rooms achieve their “cleanliness” through circulation of large quantities of usually HEPA-filtered air. Positively pressurized airlocks may be provided at entrances. Clean rooms may be small, purchased package units, or custom-built assemblies requiring extensive HVAC infrastructure. Semiconductor fabrication requires use of highly specialized equipment and very hazardous chemicals. Design of clean rooms should take place in very close coordination with the CPM project manager, the principal investigator and their School/Department, EHS, and Operations.
- 10.9 Laser Rooms
These rooms may be similar to microscopy/imaging rooms but may contain complex non-standard assemblies and instruments including laser arrays. The design team shall obtain from the principal investigator space requirements, temperature and humidity range and stability, electromagnetic and vibration requirements, necessary electrical, data and other piped services (e.g., vacuum), etc. These criteria must be vetted through CPM with the School/Department.
- 10.10 Satellite Animal Facilities (SAF)
All work with research animals should take place in a vivarium maintained and operated by the Institute for Comparative Medicine (ICM). A SAF is approved only with appropriate scientific justification and evidence that the research can't be accommodated in an existing animal facility. The ICM and Institutional Animal Care and Use Committee (IACUC) must approve the SAF, and the researcher is responsible for securing IACUC approval before operating a SAF. The design of a SAF requires significant consideration to ensure appropriate air exchange rates, temperature and humidity control, programable light/dark cycles, and special floor and wall finishes. The researcher must work in close coordination with the ICM, CPM project manager and department.

10.11 Acoustical Chambers/Shielded Rooms

These are spaces constructed as “rooms within a room” to provide a field-free acoustic/vibration environment. They may be prefabricated units or field constructed. In either case the design team must obtain from the principal investigator sound transmission and other criteria and have team expertise in this area. In addition to special construction and finishes, these spaces require special attention to HVAC and electrical design and should be developed in close coordination with Operations.

10.12 Mass Spectrometer Room

Mass spectrometers may require connection to one or more inert gas sources, often of high purity and from cylinders. In addition, these instruments will require exhaust of gases from solvents used, generally to the fume hood exhaust system. Room environmental requirements are not strict, but manufacturer's literature should be consulted. Sites with excessive particulate matter, electrostatic discharge, or condensation should be avoided. Flooring materials used should not require waxing.



Link: [Appendix11.1-LaboratoryRequirementsDataSheet.pdf \(columbia.edu\)](#)

LABORATORY REQUIREMENTS DATA SHEET

Date: / /

PROJECT LOCATION	
Building	Room Type
Level	ICR Func.
Room #	NAS#
OCCUPANCY	
Principal Investigator(s)	# Test Cells
Department Assigned	# Grad-Students
Department Occupying	# Other Staff
Type of Research	Hours of Operation
ARCHITECTURAL	
Workstations	Floor Type
Lab Bench	Wall Type
Door Type/Width	Ceiling Type/Height
HVAC	
Temp./humidity Control	REMARKS
Supplementary Cooling	
Relieve Air Pressure	
Air Filtration	
Dust Control	
Other	
ELECTRICAL & LIGHTING	
Conditioned Power	REMARKS
Stand-By Power	
Emergency Power	
Electrical Grounding	
Special Lighting	
Other	
Other	

NOTE: The ability to connect to existing building infrastructure such as electrical service, campus chilled water, or other systems will be evaluated during the design and engineering feasibility stages.

PLUMBING		Y/N	REMARKS
Lab Sink		<input type="checkbox"/>	
Frywash		<input type="checkbox"/>	
Safety Shower		<input type="checkbox"/>	
Ultra-pure Water		<input type="checkbox"/>	
D. Water		<input type="checkbox"/>	
RO Water		<input type="checkbox"/>	
Steam		<input type="checkbox"/>	
Pre-Action Sprinklers		<input type="checkbox"/>	
Acid Neutralizing Sys.		<input type="checkbox"/>	
LABORATORY GASES		Y/N	REMARKS
Compressed Air		<input type="checkbox"/>	
Vacuum Systems		<input type="checkbox"/>	
Natural Gas		<input type="checkbox"/>	
Hellum		<input type="checkbox"/>	
Argon		<input type="checkbox"/>	
Nitrogen		<input type="checkbox"/>	
Other		<input type="checkbox"/>	
Other		<input type="checkbox"/>	
TECHNOLOGY		Y/N	REMARKS
Server		<input type="checkbox"/>	
AV Equipment		<input type="checkbox"/>	
Video/Data		<input type="checkbox"/>	
Other		<input type="checkbox"/>	

NOTE: The ability to connect to existing building infrastructure such as electrical service, campus chilled water, or other systems will be evaluated during the design and engineering feasibility stages.

SPECIAL REQUIREMENTS		Y/N	REMARKS
Acoustic Req.		<input type="checkbox"/>	
Low Vibration Req.		<input type="checkbox"/>	
RF/Magnetic Shielding		<input type="checkbox"/>	
Lab Animal Use		<input type="checkbox"/>	
Biosafety Level (BSL)		<input type="checkbox"/>	
Robotics		<input type="checkbox"/>	
Alarm Systems		<input type="checkbox"/>	
Radiation Use		<input type="checkbox"/>	
DCA Controlled Subst.		<input type="checkbox"/>	
Curtains (Laser, other)		<input type="checkbox"/>	
EQUIPMENT		Y/N	REMARKS
Autoclave		<input type="checkbox"/>	
Glass Wash		<input type="checkbox"/>	
Cold Room		<input type="checkbox"/>	
Fume Hood		<input type="checkbox"/>	
Laminar Flow/BSC		<input type="checkbox"/>	
Fume Snorkel		<input type="checkbox"/>	
Optical Table		<input type="checkbox"/>	
Laser		<input type="checkbox"/>	
Incubator		<input type="checkbox"/>	
Freezer/Refrigerator		<input type="checkbox"/>	
Ice Machine		<input type="checkbox"/>	
Flammable Storage		<input type="checkbox"/>	
Glove Box		<input type="checkbox"/>	
Welding		<input type="checkbox"/>	
"Shop" tools or machinery		<input type="checkbox"/>	
For Additional equipment complete to the CU Laboratory Equipment List Sheet			
ADDITIONAL REQUIREMENTS		REMARKS	
Other		<input type="checkbox"/>	
Other		<input type="checkbox"/>	
Other		<input type="checkbox"/>	

NOTE: The ability to connect to existing building infrastructure such as electrical service, campus chilled water, or other systems will be evaluated during the design and engineering feasibility stages.



Link: [Appendix11.4-ADA Sink and EyewashModule.pdf \(columbia.edu\)](#)

11.4 ADA Sink and Eyewash Module

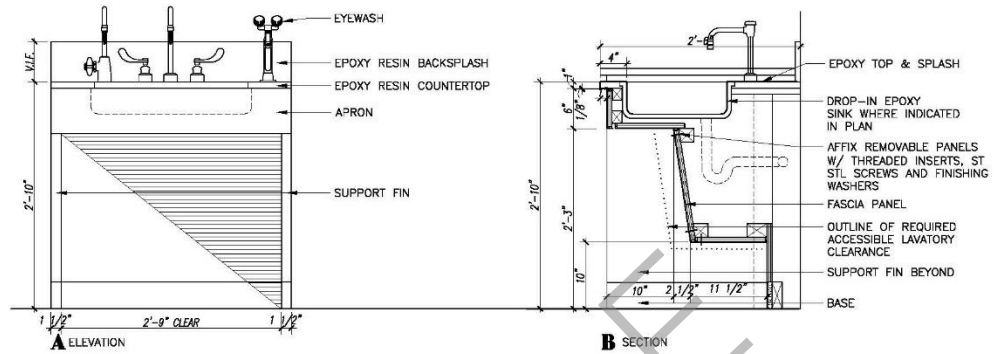

- NOTES:
1. EYEWASH UNIT SHALL BE MOUNTED 6" FROM FRONT EDGE OF COUNTER WITH SPRAY NOZZLES FACING OUT.
 2. ONE ADA COMPLIANT SINK PER LAB SHALL BE SHOWN. IF ADDITIONAL SINK MODULES ARE NEEDED, THE ADA COMPLIANT SINK SHALL BE LOCATED FOR MAXIMUM CONVENIENCE TO PERSONS WITH DISABILITIES. EYEWASH LOCATION SHALL BE AS SHOWN.

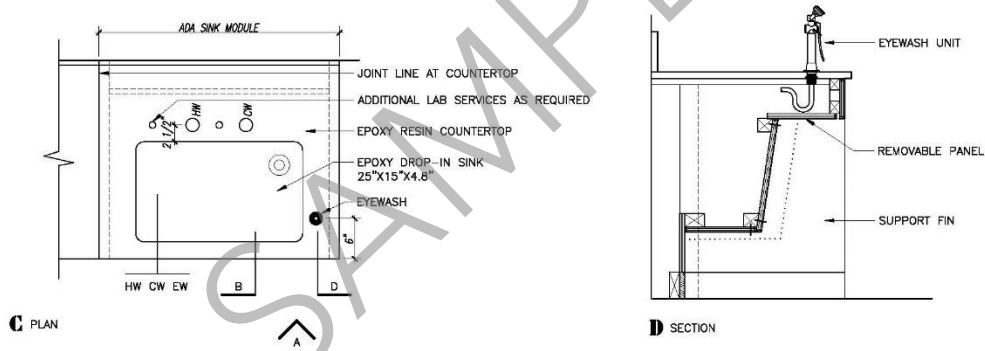

Link: [Appendix 11.5-EyewashStandard.pdf \(columbia.edu\)](#)

11.5 Eyewash Standard 1/2



WaterSaver

Eyewash / Drench Hose Units

- EW1022 Eyewash/Drench Hose Unit, Deck Mounted
- EW1022BP Eyewash/Drench Hose Unit, Deck Mounted, with Backflow Preventer

Application: Dual purpose eyewash/drench hose for deck mounting. Unit meets the provisions of ANSI Z358.1-2014 as both an eyewash and a drench hose. Unit may be left in the deck flange for use as a fixed eyewash, leaving user's hands free. Alternatively, unit may be removed for use as a drench hose to rinse any part of user's eyes, face or body.

Spray Head Assembly: Two GS-Plus™ spray heads mounted side-by-side. Each head has a "flip top" dust cover, internal flow control and filter to remove impurities from the water flow.

Valve: Forged brass squeeze valve activated by stainless steel lever handle. Valve has replaceable stainless steel seat for exceptional durability. Locking clip engages when handle is depressed, providing "hands free" operation. Valve stays open until locking clip is released.

Hose: 8' reinforced PVC hose. 275 PSI maximum working pressure.

Mounting: Deck flange for countertop mounting. Flange has handle locator guide to position spray heads and handle facing forward at all times.

Backflow Preventer: In-line dual check backflow preventer installed on inlet of hose (EW1022BP only). ASSE 1024 Listed. *Note: Check with code authority for compliance with local plumbing code.*

Supply: 3/8" NPT male swivel-type inlet.

Sign: ANSI-compliant identification sign.

Quality Assurance: Unit is completely assembled and water tested prior to shipment.

Available Options

- FSH 8 ft. flexible stainless steel hose in place of PVC hose.
- HG Undercounter hose guide bracket to prevent hose from tangling or binding.
- VB In-line vacuum breaker for installation between valve and spray head.
- AP3600 Thermostatic mixing valve precisely blends hot and cold water to deliver warm (tepid) water as required by ANSI Z358.1-2014. Refer to "Tempering Valves" section for complete technical and product selection information.



WaterSaver Faucet Co. 312 666 5500 TELEPHONE
701 W Erie St 312 666 5501 FACSIMILE
Chicago, IL 60654 wsfab.com

Listed 876C Units have been tested to and comply with ANSI Z358.1-2014 and the Uniform Plumbing Code.



11.5 Eyewash Standard 2/2



WaterSaver

Eyewash / Drench Hose Units

- EW1022 Eyewash/Drench Hose Unit, Deck Mounted
- EW1022BP Eyewash/Drench Hose Unit, Deck Mounted, with Backflow Preventer

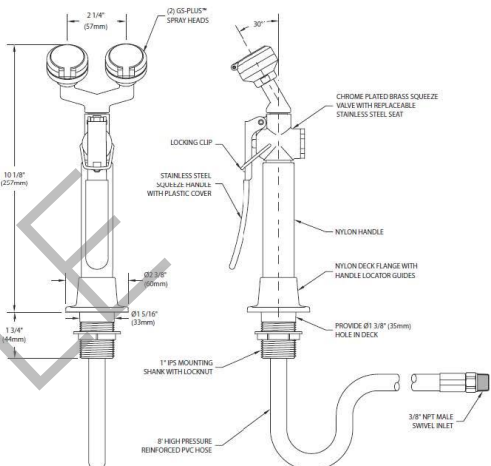

NOTES:
1. EACH GS-PLUS™ SPRAY HEAD HAS A "FLIP-TOP" DUST COVER, INTERNAL FLOW CONTROL AND FILTER TO REMOVE IMPURITIES FROM THE WATER FLOW.
2. HOSE SHOULD NOT BE USED IN APPLICATIONS WHERE WATER PRESSURE EXCEEDS 90 PSI. HOSE SHOULD BE INSPECTED PERIODICALLY FOR DEGRADATION.

REV. 05/2017

WaterSaver Faucet Co. 312 666 5500 TELEPHONE
701 W Erie St 312 666 5501 FACSIMILE
Chicago, IL 60654 wsfab.com

Listed 876C Units have been tested to and comply with ANSI Z358.1-2014 and the Uniform Plumbing Code.





Link: [Appendix11.6-LaboratorySignageChecklist.pdf \(columbia.edu\)](#)

LABORATORY SIGNAGE CHECKLIST

Legend: (Responsibility for confirming completion as indicated by color)	Capital Project Management
	Environment, Health and Safety

Laboratory Signage	Responsibility	When?	Completed
No Smoking Signage (outside rooms or areas where hazardous materials are stored or used)	PM / EH&S	Project Closeout	<input type="checkbox"/>
Laboratory Placard template (inclusive of FDNY language requirement)			<input type="checkbox"/>
Label Flammables, Acids, Eyewash, Shower, No Flammables in Refrigerator, Compressed Gas etc.			<input type="checkbox"/>
Eyewash location/testing signage			<input type="checkbox"/>
Overhead emergency shower			<input type="checkbox"/>
Posting and signage - "Caution Class IIIB Laser" or "Danger Class IV Laser" for areas containing Class IIIB or IV lasers			<input type="checkbox"/>
Provide placard inserts with laboratory hazard pictograms and emergency contact information	EH&S	Post Occupancy	<input type="checkbox"/>
Provide RAM "Sign of Signs"		Prior to occupancy	<input type="checkbox"/>
Dry and liquid RAM waste storage containers, as appropriate		<input type="checkbox"/>	
Laboratory specific Hazard signage (Magnetic Fields, other)		<input type="checkbox"/>	

2023

Link: [Appendix11.7-LaboratoryRequiredSignageSample.pdf \(columbia.edu\)](#)



New Plaque Here
53"W Wall
Recommended 60" to Center

Approved 11/25/14
Project Name: TEM Lab
Work Order:
Department:
Project:
Staff:
Status: In Production
Estimated Install Date: week of 12/22/14

Plaque - Qty: 1
10"H x 36"W x 1/4" Thick
Brushed Aluminum Plaque
3"H Engraved and Black Plaque Filled Text
Stud Mounting
Font: Helvetica Bold

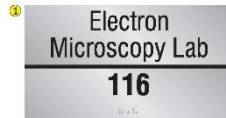

(install on right wall at entrance - 10.5"W)

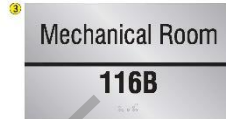

CUF-3 (Qty: 3)
4 1/8" x 7 1/8" x 1/4" Thick Frame
with Satin Anodized Aluminum Laminated
and Printed Returns to Match
Header: 5/8" Black Direct-Print Text
Footer: 3/4" Black Raised ADA Characters
and Silver Braille
5/8" Black Direct-Print Text
Double-Faced Tape / Silicone Mounting
Insert Font: Helvetica Condensed
AIM: Helvetica Condensed Bold

NO SMOKING, EATING OR DRINKING
LABORATORY
CAUTION: HAZARDOUS MATERIALS
AUTHORIZED PERSONNEL ONLY

Lab Sign (Qty: 3)
13.5"H x 18"W
White Acrylic Frame
5/8"H and 1.25"H Red ADA Characters
and Clear Grade 11 Braille on Header
4.25"H x 7.5"W Windows
with Thumblocks on Face
Double-Faced Tape / Silicone Mounting



Info Sign (Qty: 2, 1-No Smoking, 1-No Food)
9"H x 8"W x 1/8" Thick
Brushed Aluminum
with Direct-Printed Graphics
and Backlit/engraved text
Double-Faced Tape / Silicone Mounting
Confirm Mounting Location



Perpendicular Safety Signs (Qty: 3 - 1 of each)
7 1/8" x 7 1/8"
Painted Acrylic
with White Vinyl Text / Graphics
Silver Perpendicular Bracket
Screw and Anchor Mounting

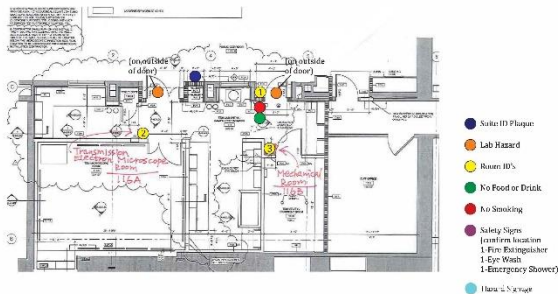

Link: [Appendix 11.8-LaboratoryPermitChecklist.pdf \(columbia.edu\)](#)

Project: _____

Date: _____

FDNY Laboratory Permit Documents				
Laboratory Permit Documents	Document Source	Task	When?	Completed
Basis of Design Report: Provide a copy of the report indicating design air changes per hour.	Architect / Engineer	PM collects the required air change information.	Schematic Design approval	<input type="checkbox"/>
Architectural Floor Plans: Copy of DOB approved floor plans, with DOB barcode and stamp* indicating fire rating of walls, partitions and fire doors.	Architect / Exeocitor	PM collects the required A/MEP/FP set.	Prior to start of construction.	<input type="checkbox"/>
Fire Protection Plans: Copy of DOB approved and stamped* fire suppression system (i.e., sprinkler) diagram.	Engineer / Exeocitor			<input type="checkbox"/>
Mechanical Plans: Copy of DOB approved with barcode and stamp indicating fume hood duct systems.	Engineer / Exeocitor			<input type="checkbox"/>
Compressed Gas Manifold: Evidence from manufacturer that manifold headers are capable of withstanding 3000 psig (e.g., manufacturer's specifications or product literature).	Contractor	PM collects manifold performance criteria	Construction Submittal Phase	<input type="checkbox"/>
Blackout and Laser Curtains: Flame Resistant (if installed): Documentation or affidavit from the manufacturer stating such curtains are Inherently Flame Resistant as per NFPA 701. Curtains must be tested, and documentation issued, by FDNY Certificate of Fitness holder (C-F5). Notarized Affidavit must also state building and room numbers where curtains are installed.	Curtain Vendor (CJ preferred vendor is G.M.I. Inc.)	PM collects document	Construction Submittal Phase	<input type="checkbox"/>
ASHRAE 110: test report for all chemical fume hoods stamped.	Cx / EH&S	1. PM includes test requirement in project spec. 2. Contractor issues report to A/E for review and approval, CxA for review and comment. 3. Cx provides a copy to PM	Project Closeout	<input type="checkbox"/>
Testing and Balancing Report: Copy of room air balance report stamped, showing the calculated Air Changes per Hour.	Cx			<input type="checkbox"/>

2023

1/2

Fume hood face velocity certification: after successful ASHRAE 110.	EH&S	PM collects certificate from EH&S	Project Closeout	<input type="checkbox"/>
Compressed Gas Distribution: Notarized affidavit/statement from NYC licensed plumber that piping from manifold header has been tested at 1 1/2 times working pressure, but not less than 100 psi. No drop in pressure for 30 minutes. Must state building and room numbers on affidavit.	Cx	1. PM includes test requirement in project spec. 2. Contractor issues report A/E for review and approval, CxA for review and comment. 3. Cx provides a copy to PM.	Project Closeout	<input type="checkbox"/>

Chemical Waste Storage Room Permit (in addition to above)	Document Source	Task	When?	Complete
Fire Alarm Drawings: Copy of DOB and FDNY Tech Management barcode approved plans with copy of FDNY Tech. Mgmt. Approval Letter. Note: Chemical Storage Room plans must be submitted in triplicate, along with fee and TM-1 & PW-1 application (Link below) to FDNY Tech Management prior to FDNY Inspection.	Exeocitor	PM collects drawings and letter.	Prior to start of construction.	<input type="checkbox"/>
Electrical Approval: Notarized affidavit/statement from NYC licensed electrician on company letterhead that all electrical equipment has been installed in accordance with the NYC Electrical Code. Affidavit must include building and room number and statement "... were installed in compliance with 3RCNY 2706.01(C)(1) in accordance with NYC Electrical Code and complies with the requirements for Class 1, Group D, Division 2 locations."	Exeocitor	PM collects letter	Project Closeout	<input type="checkbox"/>

NOTE – Effective 2020, for chemical storage rooms accessory to laboratories all required documents are to be submitted directly to the FDNY Laboratory Unit (and not via form TM-1 application to Technology Management Unit). Project Managers should prepare all requisite documentation in an electronic packet for delivery to EH&S and subsequent submission to FDNY

2023

2/2



Link: [Appendix11.9-BuildingLabInfrastructure.pdf \(columbia.edu\)](#)

COLUMBIA UNIVERSITY IN THE CITY OF NEW YORK														LAB BUILDING INFRASTRUCTURE MORNINGSIDE CAMPUS			
BUILDING	YEAR-ROUND CHILLED WATER	2ND REHEAT WATER	STEAM	GENERATOR	STANDBY POWER	WATER					GAS			IT	EXHAUST (GENERAL BUILDING)	FUME HOOD CAPACITY (FUME HOOD EXHAUST)	
						DOMESTIC COLD (POTABLE)	PROCESS LAB CHILLED WATER	DOMESTIC HOT	SECONDARY LAB HOT	PURIFIED WATER RO/DI	COMPRESSED AIR	VACUUM	NATURAL GAS				
Havemeyer																	
Havemeyer Extension																	
Chandler																	
Northwest Corner Building																	
Pupin																	
CEPSR																	
Mudd																	
Engineering Terrace																	
Fairchild																	
Schermerhorn																	
Schermerhorn Extension																	

